

GREISINGER

Oxygen Meter for oxygen in gases
with integrated temperature and pressure measuring

As of Version 1.0

Operating Manual

GMH 3695



Please keep for future reference!



WEEE-Reg.-Nr. DE 93889386



GHM Messtechnik GmbH • Standort Greisinger

Hans-Sachs-Str. 26 • D-93128 Regenstauf

☎ +49 (0) 9402 / 9383-0 📠 +49 (0) 9402 / 9383-33 📧 info@greisinger.de

Contents

1	GENERAL NOTE	2
2	DESIGNATED USE	3
3	SAFETY	3
3.1	SAFETY SIGNS AND SYMBOLS	3
3.2	SAFETY GUIDELINES	3
4	PRODUCT DESCRIPTION	4
4.1	SCOPE OF SUPPLY	4
4.2	OPERATION AND MAINTENANCE ADVICE	4
4.3	START OF OPERATION	4
4.4	CONNECTIONS	5
4.5	DISPLAY ELEMENTS	5
4.6	PUSHBUTTONS	5
4.7	POP-UP CLIP	6
5	CONFIGURATION	7
6	OXYGEN MEASURING IN GASES- PLEASE NOTE	8
6.1	CHOICE OF SENSING ELEMENTS#	9
6.2	APPLICATION OF THE DIFFERENT SENSOR TYPES GGO ..., GOO ... AND GGA	9
7	CALIBRATION OF THE SENSOR	10
7.1	ONE POINT CALIBRATION ('CAR 1-PE')	10
7.2	2 / 3-POINT CALIBRATION ('CAR 2-PE, CAR 3-PE')	10
7.3	EVALUATION OF SENSOR STATE (ELEC)	10
8	OPERATION OF THE LOGGER	11
8.1	„FUNC-STOR“: STORING SINGLE MEASUREMENT SETS	11
8.2	„FUNC-CYCL“: AUTOMATIC RECORDING WITH SELECTABLE LOGGER-CYCLE-TIME	12
9	INSPECTION OF THE ACCURACY / ADJUSTMENT SERVICES	12
10	OUTPUT	13
10.1	INTERFACE - BASE ADDRESS ('ADR.')	13
10.2	ANALOGUE OUTPUT – SCALING WITH DAC.0 AND DAC.1	13
11	GLP	14
11.1	CALIBRATION INTERVAL (CInt)	14
11.2	CALIBRATION STORAGE (READ CAL)	14
12	ALARM („AL.“)	14
13	REAL TIME CLOCK („CLOC“)	14
14	ERROR AND SYSTEM MESSAGES	15
15	SPECIFICATION	16
16	RESHIPMENT AND DISPOSAL	16

1 General Note

Read this document carefully and get used to the operation of the device before you use it. Keep this document within reach for consulting in case of doubt.

If the device is stored at temperatures above 50°C the battery has to be removed from the device.

NOTE: *We recommend taking out battery if device is not used for a longer period of time.
Risk of leakage!*



2 Designated Use

The GMH 3695 is measuring oxygen in air and gas mixtures either as partial pressure or as concentration in %vol.

For the measuring an external sensor of the type GOO-... or GGO... has to be connected to the MINI-DIN-socket.

Due to the properties of the sensor, it has to be calibrated regularly (e.g. at fresh air = 20.95%) to get precise values. If the sensor is used up, this will be detected during the calibration, the sensor has to be regenerated or replaced before continuing with measuring.

The safety requirements (see below) have to be observed.

The device must be used only according to its intended purpose and under suitable conditions.

Use the device carefully and according to its technical data (do not throw it, strike it, ...)

Protect the device from dirt.

3 Safety

3.1 Safety signs and symbols

Warnings are labeled in this document with the followings signs:



Caution! This symbol warns of imminent danger, death, serious injuries and significant damage to property at non-observance.



Attention! This symbol warns of possible dangers or dangerous situations which can provoke damage to the device or environment at non-observance.



Note! This symbol point out processes which can indirectly influence operation or provoke unforeseen reactions at non-observance.

3.2 Safety guidelines

This device has been designed and tested in accordance with the safety regulations for electronic devices. However, its trouble-free operation and reliability cannot be guaranteed unless the standard safety measures and special safety advises given in this manual will be adhered to when using the device.

1. Trouble-free operation and reliability of the device can only be guaranteed if the device is not subjected to any other climatic conditions than those stated under "Specification".

If the device is transported from a cold to a warm environment condensation may cause in a failure. In such case make sure the device temperature has adjusted to the ambient before trying a new start-up.

2.  If there is a risk whatsoever involved in running it, the device has to be switched off immediately and to be marked accordingly to avoid re-starting.

DANGER

Operator safety may be a risk if:

- there is visible damage to the device
 - the device is not working as specified
 - the device has been stored under unsuitable conditions for a longer time.
- In case of doubt, please return device to manufacturer for repair or maintenance.

3.  Do not use these products as safety or emergency stop devices or in any other application where failure of the product could result in personal injury or material damage.

DANGER

Failure to comply with these instructions could result in death or serious injury and material damage.

4.  This device must not be used at potentially explosive areas! The usage of this device at potentially explosive areas increases danger of deflagration, explosion or fire due to sparking.

DANGER

4 Product Description

4.1 Scope of supply

The scope of supply includes:

- GMH 3651 with 9V-batterie
- Oxygen sensor GWO 3600
- Operating Manual

4.2 Operation and maintenance advice

1. Battery operation

If \triangle and 'bAt' are shown in the lower display the battery has been used up and needs to be replaced. However, the device will operate correctly for a certain time. If 'bAt' is shown in the upper display the voltage is too low to operate the device; the battery has been completely used up.



The battery has to be taken out, when storing device above 50 °C.

We recommend taking out battery if device is not used for a longer period of time.

After recommissioning the real-time clock has to be set again.

2. Mains operation with power supply

When using a power supply please note that operating voltage has to be 10.5 to 12 V DC.



Do not apply overvoltage!! Cheap 12V-power supplies often have excessive no-load voltage.

We, therefore, recommend using regulated voltage power supplies.

Trouble-free operation is guaranteed by our power supply GNG10/3000.

Prior to connecting the power supply to the mains make sure that the operating voltage stated at the power supply is identical to the mains voltage.

3. Treat device and sensor carefully. Use only in accordance with above specification. (do not throw, hit against etc.). Protect plug and socket from soiling.

4.3 Start of Operation

Switch the device on with the key "ON OFF". The Instrument is performing a self diagnosis, during this time all display segment are shown.

Afterwards the instrument signals, if it was user adjusted („Err“)

The device starts measurement afterwards.

4.4 Connections

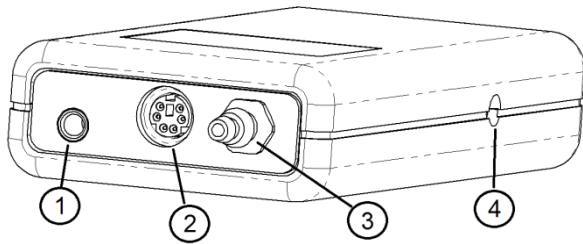

2. **Sensor connection** MiniDIN

3. **Pressure Port:** Tube Connection for ambient pressure compensation of oxygen Sensor

4. **Power supply:** d.c.connector (internal pin Ø 1.9 mm) for external 10.5-12V direct voltage supply

1. **Output:** Operation as interface for the connection of galvanically isolated adapters (accessories: GRS 3100, USB 3100)

Operation as analogue output: connection via suitable analogue cable

Attention: The mode of operation has to be configured (p.r.t Chapter 5) and influences the power consumption.

4.5 Display elements

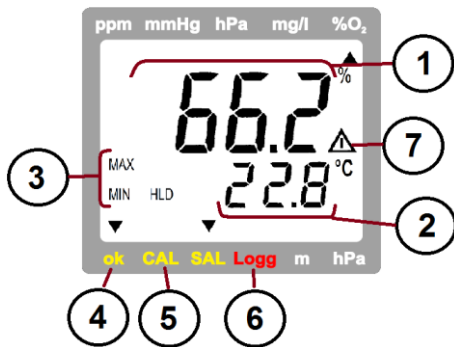

1 = **Main Display:**

Possible displays:

- Oxygen concentration in % (% O₂ Vol)
- Oxygen partial pressure (hPa or mmHg)

(change with -key)

2 = **secondary display:**

Display of sensor temperature or absolute pressure (alternating, please refer to Chapter 5. *Lcd.2*)

Special elements:

3 = **MIN/MAX/HLD:**

Shows, if minimum/maximum/memorized measuring value is in display
Signals, if oxygen and temperature values are stable

4 = **ok-arrow:**

Signals, if automatic calibration is in progress

5 = **CAL- arrow:**

6 = **Logg - arrow**

Shows, if logger function is chosen.

Is blinking, if cyclic logger is running

7 = **Warning sign:**

Signals weak battery or other warning message

Die restlichen Pfeile haben in dieser Gerätevariante keine Funktion

4.6 Pushbuttons



On / off key

Set/Menü

Press 2 sec.: (Menu): call configuration menu
Press shortly: Change the oxygen display unit (please refer to chapter 5)

min/max when taking measurements:

press shortly: min. or max. measured oxygen value and referring temperature and pressure values will be displayed

press for 2 sec.: the min. or max. value will be deleted

Configuration: to enter values, or change settings



Store/Enter

- Measuring: with Auto-Hold off: hold and save current measuring value ('HLD' is displayed)
with Auto-Hold on: start new measuring, It is finished, when "HLD" shows in display
or if logger activated: calling the logger functions (refer to chapter 8)

- Set/Menu: confirm settings, return to measuring



CAL:

- press shortly: display of sensor state rating
- press for 2 sec: start sensor calibration

4.7 Pop-up clip

Handling:

- Pull at label “open” in order to swing open the pop-up clip.
- Pull at label “open” again to swing open the pop-up clip further.

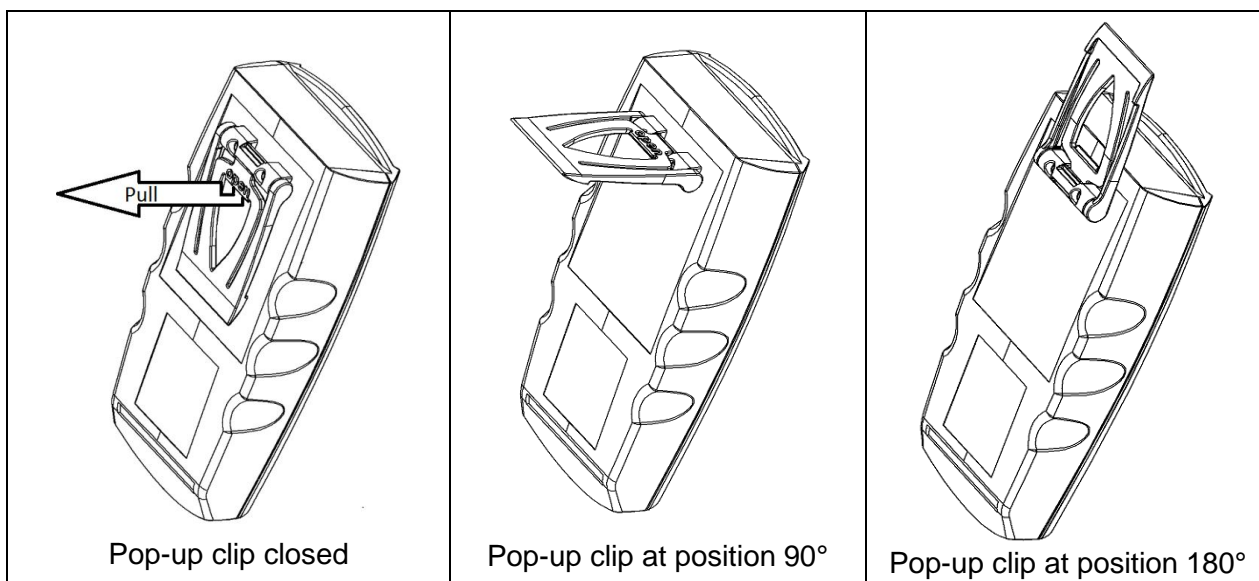

Function:



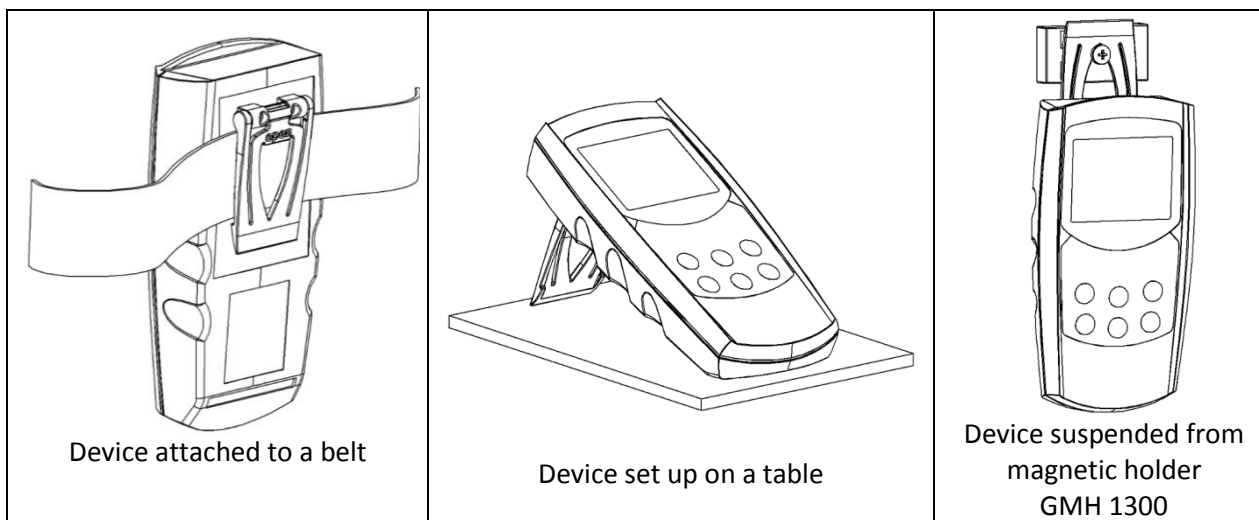

- The device with a closed pop-up clip can be plainly laid onto a table or attached to a belt, etc.
- The device with pop-up clip at position 90° can be set up on a table, etc.
- The device with pop-up clip at position 180° can be suspended from a screw or the magnetic holder GMH 1300.







5 Configuration



Some menu points depend on current device settings.

To change device settings, press „Menu“  for 2 seconds. This will activate the configuration menu (main display: "Set"). Pressing „Menu“  changes between the menus points, pressing  jumps to the referring parameters, which can be selected with key .

The parameters can be changed with  or . Pressing „Menu“  again jumps back to the main configuration menu and saves the settings. "Store"  finishes the configuration and returns to measuring.

Menu	Parameter	Value	Description			
key Menu	key ▶	key ▲ or ▼			p.r.t	
SEt Conf	Set Configuration: General configurations					
	Ch 2	P 02	hPa	Oxygen partial pressure display in hPa	*	
		P 02	mmHg	Oxygen partial pressure display in mmHg		
	Lcd.2	t		Second. display always temperature		
		P		Second. display always absolute pressure		
		P t		Second. display alternates between temperature and abs. pressure		
	Unit	t	°C	All temperatures in degree Celsius (ex works setting)		
		t	°F	All temperatures in degree Fahrenheit		
	CALP	1-Pt		Simple one point calibration at air		
		2-Pt		2 point calibration at air and 0% (e.g. N ₂) or 100 %		
		3-Pt		2 point calibration at air and 0% (e.g. N ₂) and 100 %		
	C. Int	1 ... 365		Calibration reminder period (in days)		
		oFF		No calibration reminder		
	Auto HLD	on		Auto measuring value identification Auto Hold (when logger = off)		
		oFF		Standard hold function on key press (when logger = off)		
	P.oFF	1 ... 120		Power-off delay in minutes. Device will be automatically switched off as soon as this time has elapsed if no key is pressed/no interface communication takes place. (ex works setting 20min)		
		oFF		Automatic power-off function deactivated (continuous operation)		
	Out	oFF		Interface off -> minimal power consumption		
		SEr		Serial interface activated (ex works setting)		
		dAC		Analogue output activated		
Adr	01,11,21, ... 91		Base address for serial interface communication (ex works setting 01)			
dA. n	Conc		Analogue output is showing concentration in %			
	P.02		Analogue output is showing partial pressure in hPa or mmHg			
dA.C.0	0.0...100.0	%O ₂	Measuring value which should correspond to output 0 V e.g. 0.0 % -> 0 V, (ex works 0,0 %O ₂)			
dA.C.1	0.0...100.0	%O ₂	Measuring value which should correspond to output 1 V e.g. 100.0 % -> 1 V (ex works 100,0 %O ₂)			
SEt Corr	Set Corr: Input adjustment					
	OFFS °C or °F	-5.0 °C .. 5.0 °C or -9.0 °F .. 9.0 °F		The zero point of the temperature measuring is shifted for the entered value. This can be used to compensate sensor and instrument deviations		
		oFF		No zero adjustment for temperature measurement (=0.0°)		
		SCAL °C or °F	-5.00 ... 5.00 %		The slope of the temperature measurement is corrected by this value. This can be used to compensate sensor and instrument deviations	
	oFF		No slope adjustment for temperature measurement (=0.00)			
	OFFS hPa	-20 .. 20	hPa	The zero point of the pressure measuring is shifted for the entered value. This can be used to compensate sensor deviations		
oFF			No zero adjustment for pressure measurement (=0.0°)			

Set Alarm			
SET AL	AL. 1	on / no.5o	Monitoring Oxygen: Alarm on with buzzer / Alarm on without buzzer
		oFF	No alarm monitoring for oxygen
	AL. n	Conc	Monitoring Oxygen: Concentration in %
		P. O ₂	Monitoring Oxygen: Partial pressure in hPa or mmHg
	A1.Lo	e.g. 0.0..100.0 %	Min alarm limit oxygen (not if AL. 1. oFF)
	A1.hi	e.g. 0.0..100.0 %	Max alarm limit oxygen (not if AL. 1. oFF)
	AL. 2	on / no.5o	Temperature monitoring : Alarm on with buzzer / Alarm on without buzzer
		oFF	No alarm monitoring for temperature
A2.Lo	-5.0..+ 50.0 °C	Min alarm limit temperature (not if AL. 2. oFF)	
A2.hi	-5.0..+ 50.0 °C	Max alarm limit temperature (not if AL. 2. oFF)	

Set Logger			
SET LoGG	Func	CYCL	Cyclic logger function
		Stor	Store: manual recording
		oFF	No logger activated
CYCL	0:01 ... 60:00	Cycle time in [minutes:seconds] for cyclic logger	*
Set Clock			
SET CLOC	CLOC	HH:MM	Clock: set time hours:minutes
	YEAR	YYYY	Year: set year
	DATE	TT.MM	Date: set date day.month



Pressing “menu” and “store” at the same time for more than 2 seconds will reset the device to factory defaults

If there are data sets stored and logger is set to “manual recording” (“Func Stor”) the first menu point displayed is “rEAd Logg” (p.r.t. chapter 8)

If no key is pressed for more than 2 minutes the configuration will be aborted. All changes will not be saved!

6 Oxygen Measuring in Gases- Please Note

The GMH 369x is designed for measuring the oxygen partial pressure or the oxygen concentration (%vol, calculated from partial pressure and ambient pressure) in gases. Please keep in mind:

- **The sensor has to be calibrated regularly, e.g. at fresh ambient air**
- **The calibration and the measuring are pressure depending!**
The instrument automatically measures the ambient pressure, be sure, that instruments pressure is the same like the pressure at the sensors membrane. For the full automatic compensation a precision pressure sensor is integrated in the instrument.
- **The sensor temperature has to be the same like the gas temperature!**
*Temperature differences may falsify the results!
Please have in mind that temperature adoption of the sensor and the air may take several hours.
A suitable ventilation or gas flow around the sensor would speed up this process significantly.*

The sensor consists of a sensing element (GOEL xxx) enclosed in a sensor housing (GGO/ GGA/GOO). When purchasing a Sensor GGO/GGA/GOO xxx, a sensor element is already integrated, e.g. a GGO 370: contains housing GGO and a sensor element GOEL 370.

6.1 Choice of Sensing Elements#

GOEL 370:

Universal sensor element with special protection measures especially for diving application ("Nitrox"). Very long life time, also suitable for application with larger CO₂ concentrations.

GOEL 380:

Fast responding for low oxygen concentration e.g. protection atmosphere below 1%, max 25%. For application without larger CO₂ concentration.



Sensors are not allowed to be used in „under-Water-Diving-Application (e.g. Rebreather)

DANGER

6.2 Application of the different sensor types GGO ..., GOO ... and GGA

GGO (closed sensor)



For measurements at atmosphere and in systems without over or under pressure the GGO... is sufficient. Additionally the GGO can be screwed tightly into systems with small over or under pressure. Attention! Mind the maximum pressure and the maximum pressure difference at the membrane. If instrument and sensor pressure are different, please connect the pressure port of instrument to measuring pressure, otherwise it will be compensated wrong!

GOO 370 / 380 (open sensor)



The sensor is equipped with drillings at the end and because of its special construction the measuring gas streams optimally around the sensor. No pressure can appear while gas blows to the sensor, which otherwise would result in erroneous measures. The temperature compensation speed of the sensor also is optimised by this design.

Especially the measuring of gases from compressed gas bottles, where the expansion of the gas leaving the bottle lowers the temperature, is optimised with regard to the temperature compensation and pressure errors. The gas flow should be chosen in a suitable range, where no overpressure can happen, esp. if the sensor is connected directly to the source e.g. by means of a tube.

GGA (closed sensor with pressure port)



Especially at **systems with over or under pressure** or at dynamic pressure due to gas flow this type is optimal. It can be screwed tightly into systems with small over or under pressure.

Attention! Mind the maximum pressure.

The instrument pressure port is connected directly to the sensor port. Then the actual pressure at the membrane will be measured and compensated automatically.

7 Calibration of the Sensor

In order to compensate for ageing of the sensor, the sensor has to be calibrated at regular intervals. The device is equipped with a easy-to-use calibration functions.

We recommend to calibrate the sensor at least all 7 days, or to get maximum precision, before each measuring series.

7.1 One Point Calibration ('CAL 1-Pt')

The calibration adjusts the sensor to the oxygen content of the atmosphere (20.95%). Therefore simply expose the sensor to the ambient air (sufficient ventilation in closed rooms has to be ensured)

Start calibration: press -key for 2 seconds

The display will show 'Pt. 1' and as soon the values for oxygen and temperature are stable, the calibration will be finished

Then the electrode state resulting of the successful calibration will be shown for a short time (evaluation in 10% steps: xx% ELEC).

7.2 2 / 3-Point Calibration ('CAL 2-Pt, CAL 3-Pt')

The sensor will be automatically calibrated to the oxygen content of the atmosphere (20.95%) and one or two additional concentrations. As reference gases usually Nitrogen (0% vol O₂) or pure oxygen are used

1. **Start calibration: press -key for 2 seconds**
2. **First calibration reference: (Pt.1)**

As first reference at a 3-point calibration, the zero reference has to be applied (NULL), at a 2-point calibration either 100% or 0%(NULL).

The display will show 'Pt. 1', and the referring reference which should be applied:

- NULL for 0% oxygen
- 0.2 for pure oxygen

As long as the display blinks, no valid reference is recognised by the instrument.

As soon the values for oxygen and temperature are stable, the calibration of the first point will be finished. The instrument tells you to apply the next reference (possible references are blinking in the display).

3. **Second calibration reference: (Pt.2)**

The display will show 'Pt. 2', and the referring reference which should be applied:

- Pt. 1 for ambient air
- 0.2 for pure oxygen
- NULL for 0% oxygen

As long as the display blinks, no valid reference is recognised by the instrument.

As soon the values for oxygen and temperature are stable, the calibration of the second point will be finished. At 2-point calibration the calibration will be finished and the electrode state resulting of the successful calibration will be shown for a short time (evaluation in 10% steps: xx% ELEC).

At 3-point calibration the instrument tells you to apply the next reference (possible reference is blinking)

4. **Third calibration reference: (Pt.3)**

The display will show 'Pt. 3', and the referring reference which should be applied:

As soon the values for oxygen and temperature are stable, the calibration of the second point will be finished. At 2-point calibration the calibration will be finished and the sensor state resulting of the successful calibration will be shown for a short time (evaluation in 10% steps: xx% ELEC).



In case of error messages being displayed during the calibration process, please refer to our notes at the end of this manual! If a calibration cannot be carried out after an extended period of time, at least one of the measuring values is unstable (oxygen partial pressure, temperature).

Please check your measuring arrangements!

7.3 Evaluation of Sensor State (ELEC)

Watch sensor state: press key "CAL" shortly oncedisplay show for a short time xx% ELEC.

It will show the electrode state resulting of the last successful calibration carried out.

The valuation is displayed in 10 percent steps: 100% means optimal sensor condition. Lower values are indicating that the sensor life time will be reached soon.

Remark: But also a erroneous pressure may be the cause of low valuation values.

8 Operation of the Logger

The device supports two different logger functions:

- „Func-Stor“: each time when „store“ (key 6) is pressed a measurement will be recorded.
- „Func-CYCL“: measurements will automatically be recorded at each interval, which was set in the logger menu ‚CYCL‘ until the logger will be stopped or the logger memory is full.
The recording is started by pressing „Store“ 2 seconds.

For the evaluation of the data the software GSOFT3050 (V3.5 or higher) has to be used. The software also allows easy configuration and starting of the logger.

When the logger is activated (Func Stor or Func CYCL) the hold and auto hold functions are no longer available, key 6 is solely used for the operation of the logger functions.

8.1 „Func-Stor“: Storing Single Measurement Sets

Each time when „store“ (key 6) is pressed a measurement and its time stamp will be recorded. The recorded data can be viewed either in the display (when calling the configuration an additional menu ‚REAd LoGG“ is displayed, see below) or by means of the interface and a PC with GSOFT3050-software.

The logger stores the current measuring, independent from the stability of the value.

- Max. number of data sets: 1000
- A data set contains:
- oxygen concentration % Vol
 - oxygen partial pressure in hPa or mmHg
 - temperature value at the time of recording in °C or °F
 - absolute pressure in hPa or mmHg or depth in m m
 - time and date of the recording

After each recording „St. XX“ will be displayed for a short time. XX represents the number of the recording.

Input of the measuring point „L-Id“: Selection of measuring point via keys ▲ or ▼.

Number 0...19999 or text assigned to number 1...40

(comfortable assignment of texts can be done with gratis software GMHKonfig)

Confirm input with „store“.

When logger memory contains recordings already:

When „Store“ is pressed for 2 seconds, the choice for clearing the logger memory will be displayed:



Clear all recordings



Clear the last recording



Clear nothing (cancel menu)

The selection can be made by ▲ (key 2) and ▼ (key 5). "Quit" (key 6) enters the choice.

If the logger memory is full, the display will show:



Viewing Recorded Data

Within the „LoGG Stor“ function the logger data can be viewed directly in the display not only by means of a computer (like at „Func CYCL“): press 2 seconds „Set“ (key 4): The first menu displayed now is „rEAd LoGG“ (read logger data). After pressing ▶ (key 3) the measurement recorded last will be displayed, changing between the different data referring to the measurement also is done by pressing ▶. Changing the measurement is done by pressing the keys ▲ or ▼.

8.2 „Func-CYCL“: Automatic Recording With Selectable Logger-Cycle-Time

The Logger-Cycle-Time is selectable (p.r.t. Configuration). For example „CYCL“ = 1:00: A measuring is recorded after each 60 seconds.

Max. number of data sets:	8000
Cycle time:	0:01...60:00 (minutes:seconds, min 1s, max 1h), selectable in the configuration
A data set contains:	<ul style="list-style-type: none"> - oxygen concentration % Vol - oxygen partial pressure in hPa or mmHg - temperature value at the time of recording in °C or °F - absolute pressure in hPa or mmHg or depth in m
Recording time:	<ul style="list-style-type: none"> > 20 days with fresh battery (with output activated: OUT = SEr) With mains adapter: limited just by memory and cycle time, up to 333 days

Starting a recording:

By pressing "Store" (key 6) for 2 seconds the recording will be initiated. After that the display shows 'St.XXXX' for a short time whenever a measuring is recorded. XXXXX is the number of the measuring 1..9999.

If the logger memory is full, the display will show:  The recording automatically will be stopped.

Stopping the recording manually:

By pressing "Store" (key 6) the recording can be stopped manually. Then the following choice appears:



Stop the recording



Do not stop the recording

The selection can be made by ▲ (key 2) and ▼ (key 5). "Quit" (key 6) enters the choice.



If you try to switch off the instrument in the cyclic recording operation You will be asked once again if the recording should be stopped.

***The device can only be switched off after the recording has been stopped!
The Auto-Power-Off-function is deactivated during recording!***

Clear Recordings:

When "Store" is pressed for 2 seconds, the choice for clearing the logger memory will be displayed:



Clear all recordings



Clear nothing (cancel menu)

The selection can be made by ▲ (key 2) and ▼ (key 5). "Quit" (key 6) enters the choice.

9 Inspection of the accuracy / Adjustment Services

The instrument can be sent to the manufacturer for adjustment and function test.

Only the manufacturer can check all systems on correct them if necessary.

Calibration certificates – DKD-certificates – other certificates:

If device should be certificated for its accuracy, it is the best solution to return it to the manufacturer. (please specify references, eg. 20,9 and 100%).

If the instrument is certified with its sensor, this proves for example the linearity of the measuring chain, regular recalibration by the user is still necessary!

10 Output

The output can be used as serial interface (for GRS3100 or GRS3105 interface adapters) or as analogue output (0-1V). If none of both is needed, we suggest to switch the output off, battery life then is extended.

10.1 Interface - Base Address ('Adr.')

By using an electrically isolated interface converter USB3100, GRS3100 or GRS3105 (accessory) the device can be connected to a PC.

With the GRS3105 it is possible to connect up to 5 instruments of the GMH3000 family to a single interface (please also refer to GRS3105-manual). As a precondition the base addresses of all devices must not be identical, make sure to configure the base addresses accordingly (refer menu point "Adr." in chapter 5). In order to avoid transmission errors, there are several security checks implemented (e.g. CRC).

The following standard software packages are available for data transfer:

- **GSOFT3050:** Operating and evaluation software for instruments with integrated logger function
- **EBS20M/ -60M:** 20- / 60-channel software to record and display the measuring values
- **GMHKonfig:** Software for a comfortable configuration of the device (e.g. freeware)

In case you want to develop your own software we offer a **GMH3000-development package** including

- an universally applicable 32bit Windows functions library ('GMH3000.DLL') with documentation that can be used by all 'serious' programming languages.
- Programming examples for Visual Studio 2010 (C#, C++), Visual Basic 6.0™, Delphi 1.0™, Testpoint™, Labview™

The Device has 4 Channels:

- oxygen concentration % Vol
- oxygen partial pressure in hPa or mmHg
- temperature value at the time of recording in °C or °F
- absolute pressure in hPa or mmHg or depth in m

Supported Interface-functions:

1	2	3	4	Code	Name/Function	1	2	3	4	Code	Name/Function
x	x	x	x	0	read nominal value	x	x	x	x	199	read measuring type in display
x	x	x	x	3	read system status	x	x	x	x	200	read min. display range
x				12	read ID-no.	x	x	x	x	201	read max. display range
x	x	x		22	read min alarm limit	x	x	x	x	202	read unit of display
x	x	x		23	read max alarm limit	x	x	x	x	204	read decimal point of display
x	x	x	x	176	read min measuring range	x				208	read channel count
x	x	x	x	177	read max measuring range	x				222	read turn-off-delay
x	x	x	x	178	read measuring range unit	x				223	Set turn-off-delay
x	x	x	x	179	read measuring range decimal point	x				240	Reset
x	x	x	x	180	read measuring type	x				254	read program identification



The measuring and range values read via interface are always in the selected display unit!

10.2 Analogue Output – Scaling with DAC.0 and DAC.1

With the DAC.0 and DAC.1 values the output can be rapidly scaled to Your efforts.

Keep in mind not to connect low-resistive loads to the output, otherwise the output value will be wrong and battery life is decreased. Loads above ca 10kOhm are uncritical.

If the display exceeds the value set by DAC.1, then the device will apply 1V to the output

If the display falls below the value set by DAC.0, then the device will apply 0V to the output

In case of an error (Err.1, Err.2, no sensor, etc.) the device will apply slightly above 1V to the output.

Plug wiring:

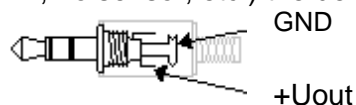

The 3rd contact has to be left floating!
Only stereo plugs are allowed!

11 GLP

GLP (Good Laboratory Practice) includes regular check of devices and accessories. For oxygen measurements it is highly important to ensure correct pH calibration. The device provides the following functions to help with this.

The usage of the GLP functions is only reasonable if the sensor is not changed. Although all data is stored in the device, it refers to the particular sensor.

11.1 Calibration interval (CAL) *(CAL)*

You can enter the interval after which the device reminds you to recalibrate in the configuration. The interval times should be chosen according to the application and the stability of the sensor. "CAL" flashes on the display as soon as the interval has expired.

11.2 Calibration storage (rEAd CAL)

The last calibrations are stored with results and date and can be read out.

Display calibration data:

Historical calibration data can be comfortably read out via PC software GMHKonfig and GSOFT3050 or displayed directly at the device:



Press for 2 seconds
The display will show:

rEAd LoBB or SEt CoNF (configuration level)



Press several times until this is displayed:

rEAd CAL. read cal. = "read calibration data"

Press shortly: switch between



- ELEc = total electrode state evaluation in %
- SL.1 = Slope at 0% ... air *1)
- SL.2 = Slope at air ... 100% *1)
- Date + time display of data set



or



Change between the different calibration data sets



Abort calibration storage display

*1 at 1 and 2-point calibration is SL.1 = SL. 2
at 3-point calibration there are different slopes for the referring range segments.

12 Alarm („AL.“)

There are three possible settings:

Alarm off (AL. oFF), on with buzzer (AL. on), on without buzzer (AL. no.So).

Following conditions will display an alarm, when the function is activated (on or no.So):

- Value is below lower (AL. Lo) or above upper alarm rail (AL.Hi).
- Sensor error
- Low battery (bAt)
- Err.7: System error (always with buzzer)











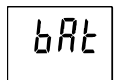



In case of an alarm and when polling the interface the "prio"-flag is set in the returned message.

13 Real Time Clock („CLOC“)

The real time clock is used for the logger and GLP functions: Recorded values are also containing the point of time, when they were measured. Please check the settings when necessary.

If the battery was replaced the referring menu ‚CLOC‘ will automatically be started

14 Error and System Messages

Display	Meaning	Remedy
	low battery voltage, device will continue to work for a short time	replace battery
	If mains operation: wrong voltage	replace power supply, if fault continues to exist: device damaged
	low battery voltage	replace battery
	If mains operation: wrong voltage	Check/replace power supply, if fault continues to exist: device damaged
No display or weird display Device does not react on keys	low battery voltage	replace battery
	If mains operation: wrong voltage	check/replace power supply, if fault continues to exist: device damaged
	system error	disconnect battery or power supply, wait some time, re-connect
	device defective	return to manufacturer for repair
	sensor error: no sensor cable connected	connect suitable sensor
	Sensor, cable or instrument defect	return to manufacturer for repair
	Value exceeding measuring range	Check: Is the value exceeding the measuring range specified? ->value too high!
	Wrong sensor connected	Check sensor
	Sensor, cable or instrument defect	return to manufacturer for repair
	Value below display range	Check: Is the value below the measuring range specified? ->value too low!
	Wrong sensor connected	Check sensor
	Sensor, cable or instrument defect	return to manufacturer for repair
	system error	return to manufacturer for repair
	either preset calibration interval has expired or last calibration is not valid	device has to be calibrated!
	wrong reference point at air	check sensor and reference gas
	slope too low	
	reference gas wrong	check sensor and reference gas
	sensor element is defect	replace sensor element
	slope too high	
	reference gas wrong	check sensor and reference gas
	sensor element is defect	replace sensor element
	incorrect calibration temperature	calibration can only be done at 0...50 °C
	Zero value to low/negative	
	sensor element is defect	replace sensor element
	zero value to high	
	reference gas wrong	check sensor and reference gas
	sensor element is defect	replace sensor element
	incorrect calibration pressure	check calibration pressure
	signal not stable / timeout	check sensor and reference gas
	sensor not known: cannot be calibrated	check sensor and wiring

If „**bAt**“ is flashing, the battery will be exhausted soon. Further measurements are possible for short time.

If „**bAt**“ is displayed continuously the battery is ultimately exhausted and has to be replaced. Further measurements aren't possible any more.

15 Specification

Measuring ranges	Oxygen concentration	0.0 ... 100.0 % O ₂ (Vol)	electrochemical sensors GGO / GOO / GGA
	Oxygen partial pressure	0 ... 1100 hPa O ₂	“ “ “
	Sensor temperature	-5.0 ... + 50.0 °C	NTC 10k (integr. in GGO / GOO / GGA cable)
	Absolute pressure	300 ... 5000 hPa abs.*)	integrated pressure sensor with pressure port
Accuracy (instrument without sensor, at 25°C, 1000 hPa abs)	Oxygen concentration	±0.1 % O ₂ (Vol)	
	Oxygen partial pressure	± 1 hPa	
	Sensor temperature	± 0.1 °C	
Accuracy	Absolute pressure	3 hPa or 0.1% of measured value (the higher one to be applied)	
Working conditions	-20 ... 50 °C; 0 ... 95 % r.H. (not condensing)		
Nom. temperature	25°C		
Storage temp.	-20 ... 70 °C		
Connections	O ₂ & temperature	6 pole Mini-DIN Socket	
	Absolute pressure	Universal pressure port for tubes with 4 or 6mm inner-Ø	
	Interface / Analogue output	serial, (3.5mm audio plug), via isolated adapter GRS3100, GRS3105 or USB3100 (accessories) for PC-USB or RS232- connection, alternatively selectable: Analogue output 0-1V	
	external supply	d.c. connector (diameter of internal pin 1.9 mm) for external 10.5-12V direct voltage supply. (suitable power supply: GNG10/3000)	
Display	4 digit 7-segment 2 lines, additional segments		
Calibration	automatic	1 -, 2- or 3-point calibration, 0%, 100% or ambient air (20.95%)	
GLP	calibration storage adjustable calibration intervals (1 to 365 days, CAL warning after expiration)		
Data logger	Real-time clock Cyclic: 8000 data sets, cycle time 1s to 60 minutes Single: 1000 data sets, with measuring point input		
Alarm	Buzzer / visual / interface 2 channels: selectable oxygen unit and temperature		
Additional functions	Min / max / hold / auto hold		
Housing	Break-proof ABS housing		
	Protection class	Front side IP65	
Dimensions L*B*H [mm]	Without pressure port: 142 x 71 x 26 mm (L x B x H)		
	Pressure port at instruments top: ca. 11 mm, approx. 175 g (incl. battery)		
Weight	approx. 175 g (incl. battery)		
Power supply	9V-Battery, Type IEC 6F22 (in scope of supply) or external supply		
Current consumption	Ca. 0.6 mA (if Out = Off ca. 0.4mA)		
Change battery indicator	Automatic at weak battery Δ and ' bAt '		
Auto-Off-Function	Device will be automatically switched off if no key is pressed/no interface communication takes place for the time of the power-off delay. The power-off delay can be set to values between 1 and 120 min.; it can be completely deactivated.		
EMI	The device corresponds to the essential protection ratings established in the Regulations of the Council for the Approximation of Legislation for the member countries regarding electromagnetic compatibility (2004/108/EG). Additional fault: <1%		

*) please note: maximum pressure of the oxygen sensor

16 Reshipment and Disposal



Dispense exhausted batteries at destined gathering places.
This device must not be disposed as “residual waste”. To dispose this device, please send it directly to us (adequately stamped). We will dispose it appropriately and environmentally friendly.



DANGER

All devices returned to the manufacturer have to be free of any residual of measuring media and other hazardous substances. Measuring residuals at housing or sensor may be a risk for persons or environment



Use an adequate transport package for reshipment, especially for fully functional devices. Please make sure that the device is protected in the package by enough packing materials.