

Pulse Valves - PL1010 Series (G3/4", G1", G1 1/2")

GENERAL FEATURES

- The pulse valves are especially used for dust collector service application or similar systems.
- Compact design, high reliability, flow rate, quality and performance; long life.
- Extremely fast opening and closing
- Working Temperature: -40°C ...160°C
- On request; with electronic timer
- Some application; dust filters, bunkers, dust extractors, electrostatic painting cabinets.
- Coils interchangeable
- Pulse valves must be used with filtered fluids.

ELECTRICAL CHARACTERISTICS

Continuous Duty	: ED %100
Coil Insulation Class	: H (180°C)
Coil Impregnation	: Polyester Fiber Glass
Ambient Temperature	: -20°C ... 80°C
Protection Degree	: IP65 (ISO 60529) On request IP68
Electric Plug Connection	: DIN 46340 3- Poles Connector(DIN43650)
Connector Specification	: ISO 4400 / EN 175301-803 Form A, Spade Plug (Cable Ø6-8 mm)
Electrical Safety	: IEC 335
Standard Voltages	: AC 12 V, 24V, 48 V, 110V, 230 V DC 12 V, 24V, 48 V, 110V

On request other voltages
 Voltages Tolerance : ± % 10
 Frequency : 50 / 60 Hz On request; LED connectors
 Please, specify coil voltage with order.

MATERIALS IN CONTACT WITH FLUIDS

Body	: Aluminium
Internal Parts	: Stainless Steel
Sealing	: Thermoplastic
Shading Ring	: Copper
Seats	: Aluminium
Core, Tube	: Stainless Steel
Spring	: Stainless Steel
Response Time	: Opening Time : 100 ms
Closing Time	: 100 ms

G1" Pulse valve air consumption example
 Pressure: 6 Bar; 50 cycle/hr
 G1" Pulse valve air consumption at 6 bar can be seen as 0,43 m3/sn from the table.
 For 50 cycle/hr, total air consumption is 0,043 x 50: 2,15 m3/h

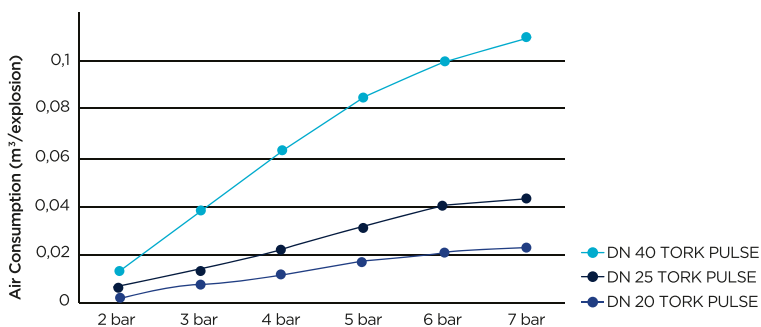

NORMALLY CLOSED

2/2 WAY

PILOT OPERATED

AIR

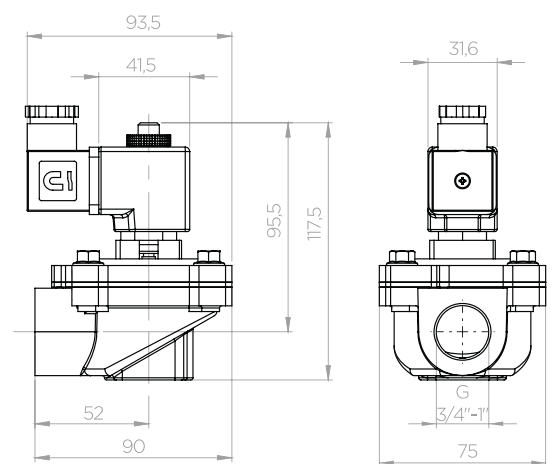
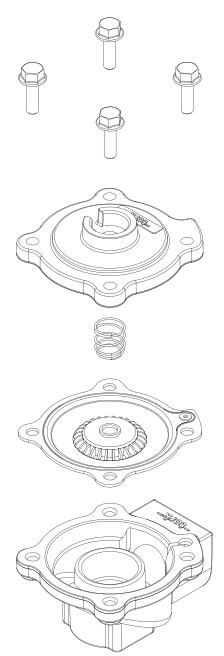

Valve Order No	Connection Size	Orifice Size	Pressure		Kv	Fluid Temperature		Sealing	Weight
			bar	Lt/min		°C			
PL1010	G	mm	min	max		min	max		(kg)
PL1010.04	3/4"	25	0,5	8	150	-10	80	NBR	0,69
						-10	160	Viton	
						-40	120	Thermoplastik	
PL1010.05	1"	30	0,5	8	270	-10	80	NBR	0,68
						-10	160	Viton	
						-40	120	Thermoplastik	
PL1010.07	1 1/2"	44	0,5	8	774	-10	80	NBR	1,4
						-10	160	Viton	
						-40	120	Thermoplastik	

• TORK Pulse Valves comply with 97/23 / EC, Pressure Equipment Directive (PED) and Low Voltage Directive 2006/95 / EEC.
 • Standard pipe connection GIBSP (ISO 228-1) is available on request. Other pipe connections can also be made on request. ((NPT) ANSI 1, 20, 31)

Pulse Valves - PL1010 Series (G2", 2 1/2", 3")

GENERAL FEATURES

- The pulse valves are especially used for dust collector service application or similar systems.
- Compact design, high reliability, flow rate, quality and performance; long life.
- Extremely fast opening and closing
- Working Temperature: -10°C ...160°C
- On request; with electronic timer
- Some application; dust filters, bunkers, dust extractors, electrostatic painting cabinets.
- Coils interchangeable
- Pulse valves must be used with filtered fluids.

ELECTRICAL CHARACTERISTICS

Continuous Duty	: ED %100
Coil Insulation Class	: H (180°C)
Coil Impregnation	: Polyester Fiber Glass
Ambient Temperature	: -20°C ... 80°C
Protection Degree	: IP65 (ISO 60529) On request IP68
Electric Plug Connection	: DIN 46340 3- Poles Connector(DIN43650)
Connector Specification	: ISO 4400 / EN 175301-803 Form A, Spade Plug (Cable Ø6-8 mm)
Electrical Safety	: IEC 335
Standard Voltages	: AC 12 V, 24V, 48 V, 110V, 230 V DC 12 V, 24V, 48 V, 110V

On request other voltages

Voltages Tolerance : ± % 10

Frequency : 50 / 60 Hz On request; LED connectors

Please, specify coil voltage with order.

MATERIALS IN CONTACT WITH FLUIDS

Body	: Casting Aluminium
Internal Parts	: Stainless Steel
Sealing	: Thermoplastic (1 1/2"), Reinforced Rubber (2", 2 1/2", 3")
Shading Ring	: Copper
Seats	: Aluminium
Core, Tube	: Stainless Steel
Spring	: Stainless Steel
Response Time	: Opening Time : 100 ms
Closing Time	: 100 ms



NORMALLY CLOSED

2/2 WAY

PILOT OPERATED

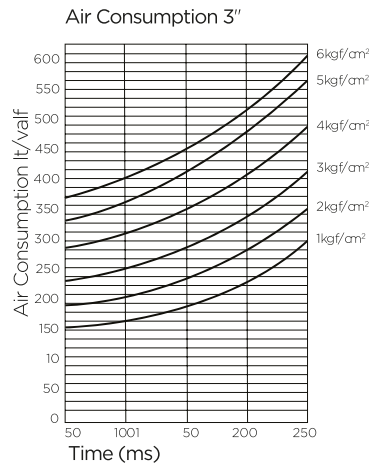
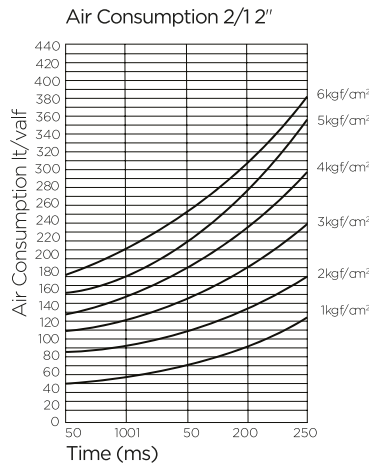
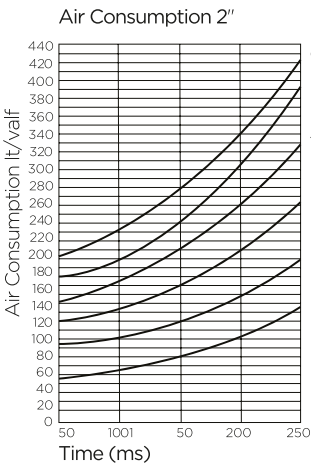
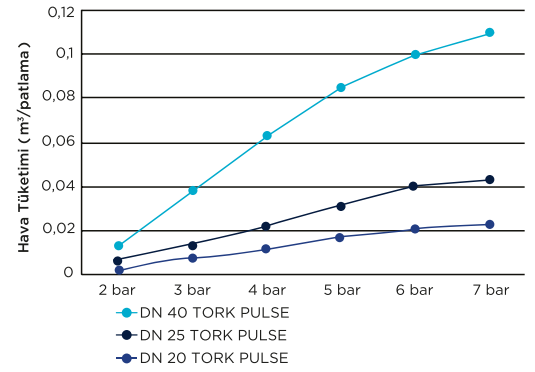

Valve Order No	Connection Size	Orifice Size	Pressure		Kv	Fluid Temperature		Sealing	Weight
			bar	Lt/min		°C	(kg)		
PL1010	G	mm	min	max		min	max		
PL1010.08	2"	50	3	8	1065	-10	80	NBR	2,25
						-10	160	Viton	
PL1010.09	2 1/2"	62	3	8	1378	-10	80	NBR	3,47
						-10	160	Viton	
PL1010.10	3"	76	3	8	2040	-10	80	NBR	3,8
						-10	160	Viton	

Pulse Valves - PL1010 Series (G2", 2 1/2", 3")

